

345 Wp SPV MODULE

Electrical Characteristics*

Nominal Maximum Power (P _m) in Watts	345
Power tolerance	0 / + 5 W
Open Circuit Voltage (V _{oc}) in Volts	46.20
Short Circuit Current (I _{sc}) in Amps	9.70
Voltage at Maximum Power (V _{mp}) in Volts	37.20
Current at Maximum Power (I _{mp}) in Amps	9.28
Maximum System Voltage in Volts	1000
Module Efficiency (%)	17.79
Maximum Series Fuse Rating (A)	15

*Under Standard Test Conditions (STC) of 1000 W/m² irradiance, AM 1.5 spectrum and 25°C cell temperature.

Mechanical Characteristics

Length x Width x Thickness (L x W x T) - mm	1960 x 990 x 40
Mounting Holes Pitch (Y) – mm	1060
Mounting Holes Pitch (X) – mm	942
Weight (kg)	22.50
Solar Cells per Module (Units) / Arrangement	72 / (12*6)
Solar Cell Type	Mono Crystalline Silicon
Front Cover (Material / Thickness)	Tempered & Low Iron Glass / 3.2mm / 4mm
Encapsulate	Ethylene Vinyl Acetate
Frame Material	Anodized Aluminum Alloy
Junction Box (Material / Type)	Weatherproof PPO / IP67 enclosure with bypass diodes
Connector (Protection degree / Type)	IP67 rated / MC4 compatible
Cable cross-section	4 mm ²

- Positive tolerance Modules
- Excellent generation performance with reasonable cost
- Undergoes rigorous quality control and in-house testing
- 100% Electroluminescence test to ensure error free Modules
- Heavy duty anodized Aluminum frames with pre-drilled holes for quick installation
- Salt mist corrosion resistance and Ammonia corrosion resistance
- Long lasting and high efficiency modules
- Withstands hail, snow and ice storms

Warranty

- 10 years Limited Product Warranty
- 25 years Limited Power output Warranty:
 - Minimum 90% at the end of 10 years
 - Minimum 80% at the end of 25 years

LINEAR DEGRADATION OF WARRANTY

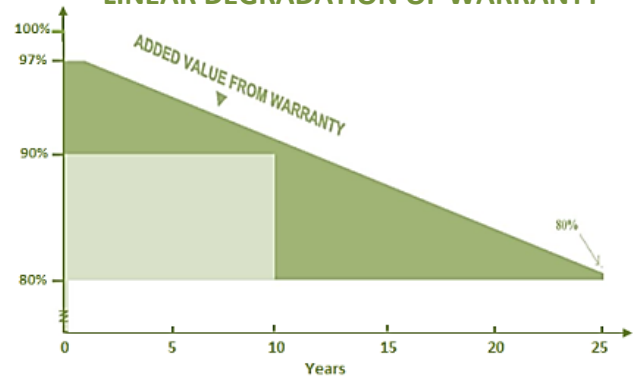

Certifications



IEC 61215



IEC 61730-1 & 2



IEC 61701



IEC 62716



ISO 9001:2008



ISO 14001:2004



OHSAS 18001:2007

Design specifications

Thermal Characteristics

Temperature coefficient of Current (I_{sc} , α (%/°C))	0.0118
Temperature coefficient of Voltage (V_{oc} , β (%/°C))	-0.2627
Temperature coefficient of Power (P_m , γ (%/°C))	-0.3677
NOCT (°C)	46 ± 2
Operating temperature range (°C)	-40 to 85

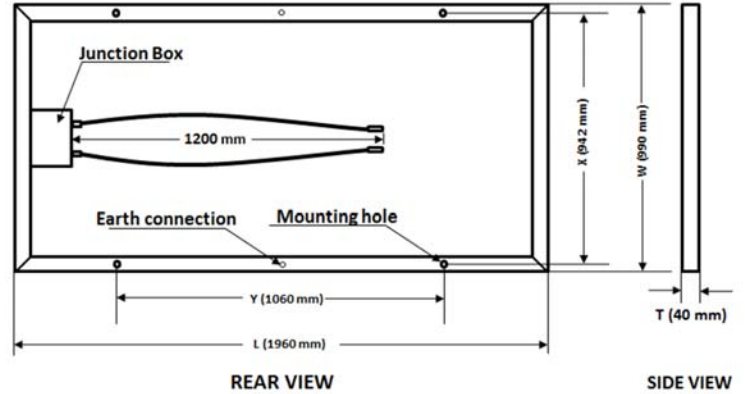

I-V Curve Variation with Irradiance

PV module: Waaree, WSM-345

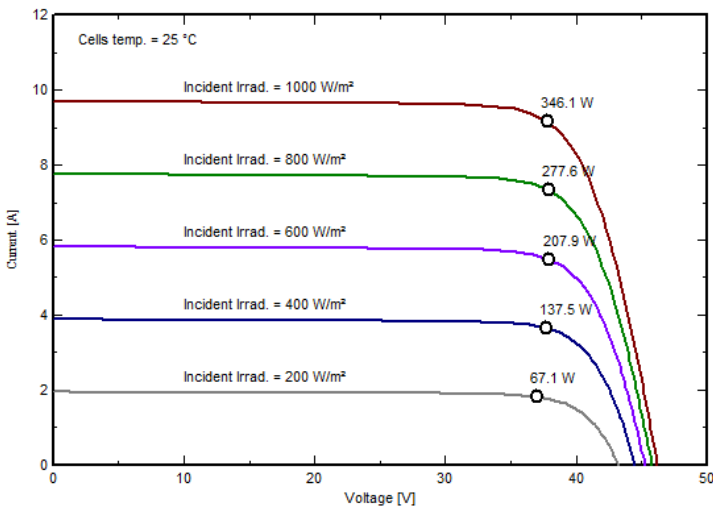

I-V Curve Variation with Temperature

PV module: Waaree, WSM-345

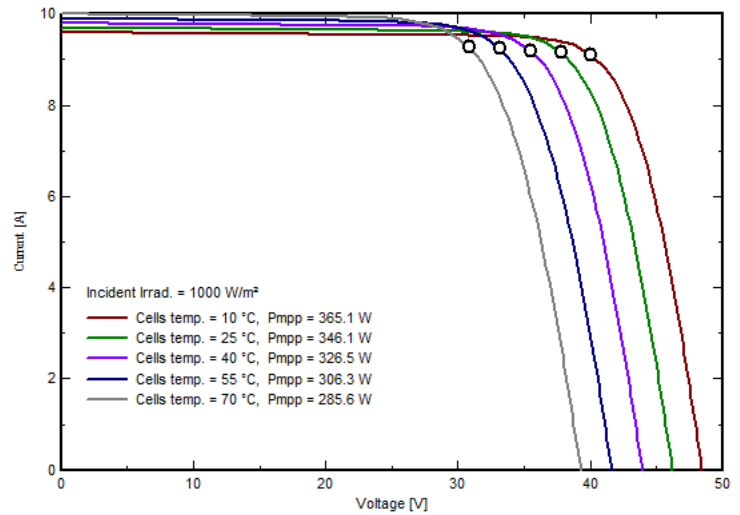

About Waaree:

WAAREE is one of India's leading multi-technology companies, headquartered at Mumbai. Founded in 1989, WAAREE successfully developed cutting edge technologies to become one of the most preferred brands in the field of Instrumentation. The company has transformed itself from a single business into a multi-technology organization, diversifying into exciting areas of Solar Energy, Industrial Valves, Petroleum Equipment's and Process control Instrumentation. WAAREE has a presence in over 68 countries, serviced through its 20 sales offices in India & Dubai, and more than 105 global channel partners. WAAREE has a huge list of satisfied customers over the years. WAAREE is committed to supply the best quality products & technology to its customers. WAAREE's products are manufactured at its state-of-the-art manufacturing facilities and is committed to excel in providing the society with world class quality products.

Contact: WAAREE ENERGIES LIMITED

602, Western Edge-I, Off. Western Express Highway,
Borivali (E), Mumbai 400066, Maharashtra
Ph.: +91-22-66444444, Fax: +91-22-66444400, Email: waaree@waaree.com

○ The specifications in this datasheet are subject to change without prior notice.